

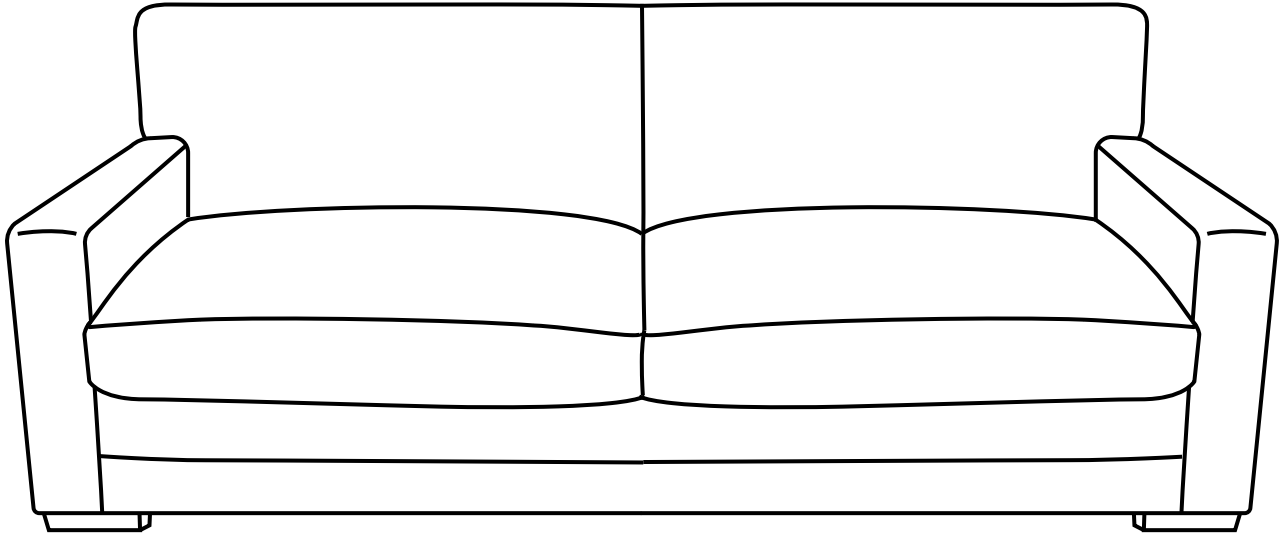

— Thank you for buying the Arden 3 Seater Sofa



Before you start:

Unpack carefully

- Take care when unpacking and assembling your sofa as damaged or scratched items cannot be returned
- Do not use sharp objects
- Be careful not to dispose of the enclosed assembly kit
- Please retain all packaging until you are 100% happy with your sofa

Before and during assembly

- This sofa requires 2 people to assemble
- Make sure all items are accounted for and clearly laid out before starting
- Make sure you have enough space to assemble the sofa safely
- Assemble the sofa where it will be placed to avoid moving unnecessarily
- Place all parts on a soft and flat surface to avoid damage
- Make sure backrests are slotted in evenly and not at an angle
- Do not use power tools or overtighten any fittings as this can cause damage
- If the upholstery is creased, plump the cushions and allow the sofa to settle at room temperature
- Carefully trim off any loose threads

Caution

- Keep small parts, plastic bags and film away from children



— In the box

A x 1

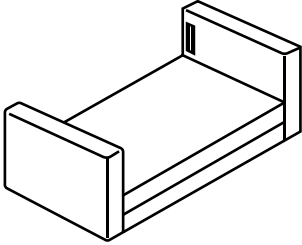

Sofa Frame

B x 1

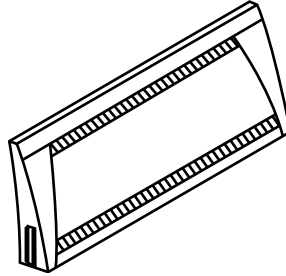

Backrest

C x 2

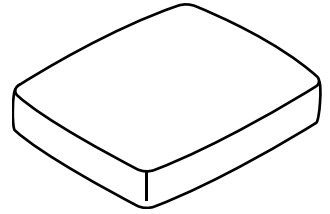

Seat Cushion

D x 1

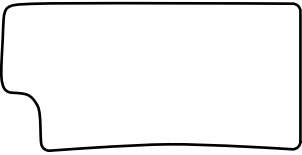

Left Back Cushion

E x 1



Right Back Cushion

F x 4

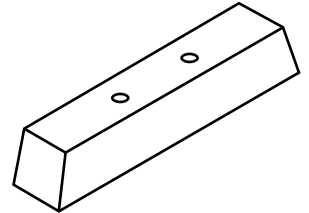

Foot

G x 8

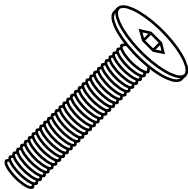

Bolt M8x60mm

H x 1



Allen Key 5mm



1 Attach the feet to the sofa as shown.

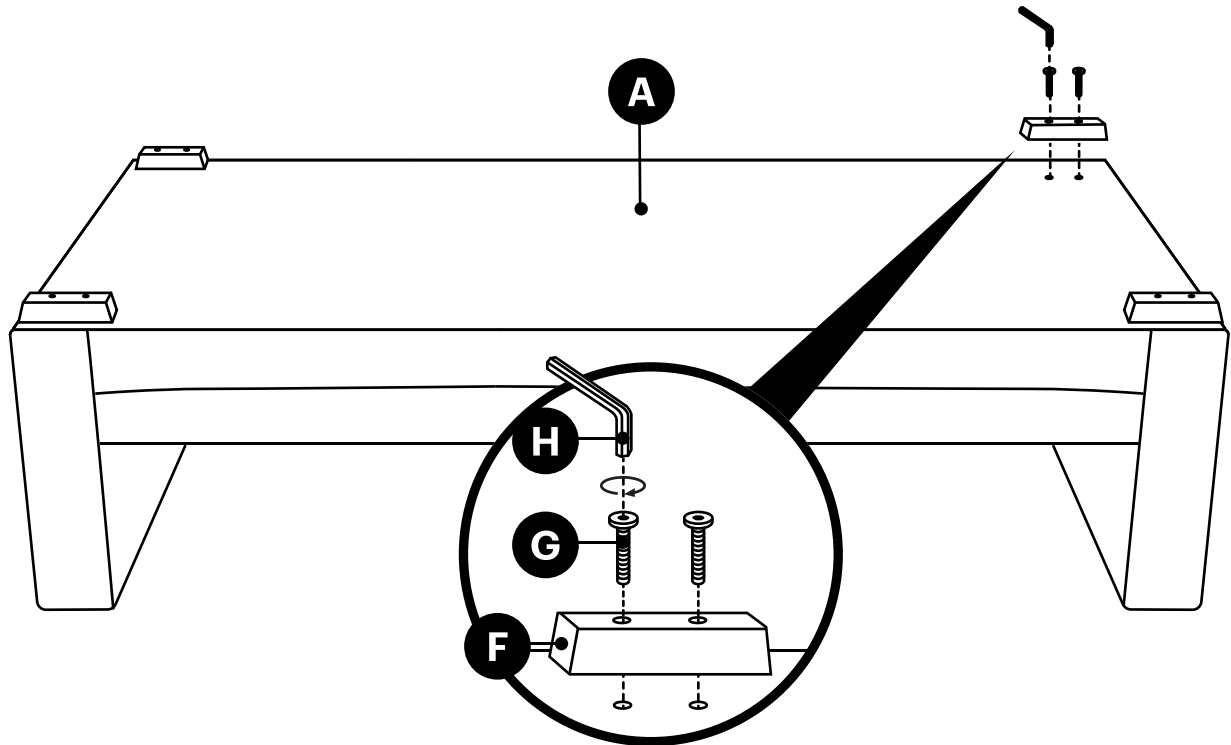

2 Attach the backrest. With one person on each side, slot the backrest into the right and left brackets at the same time. Then push down evenly and firmly.

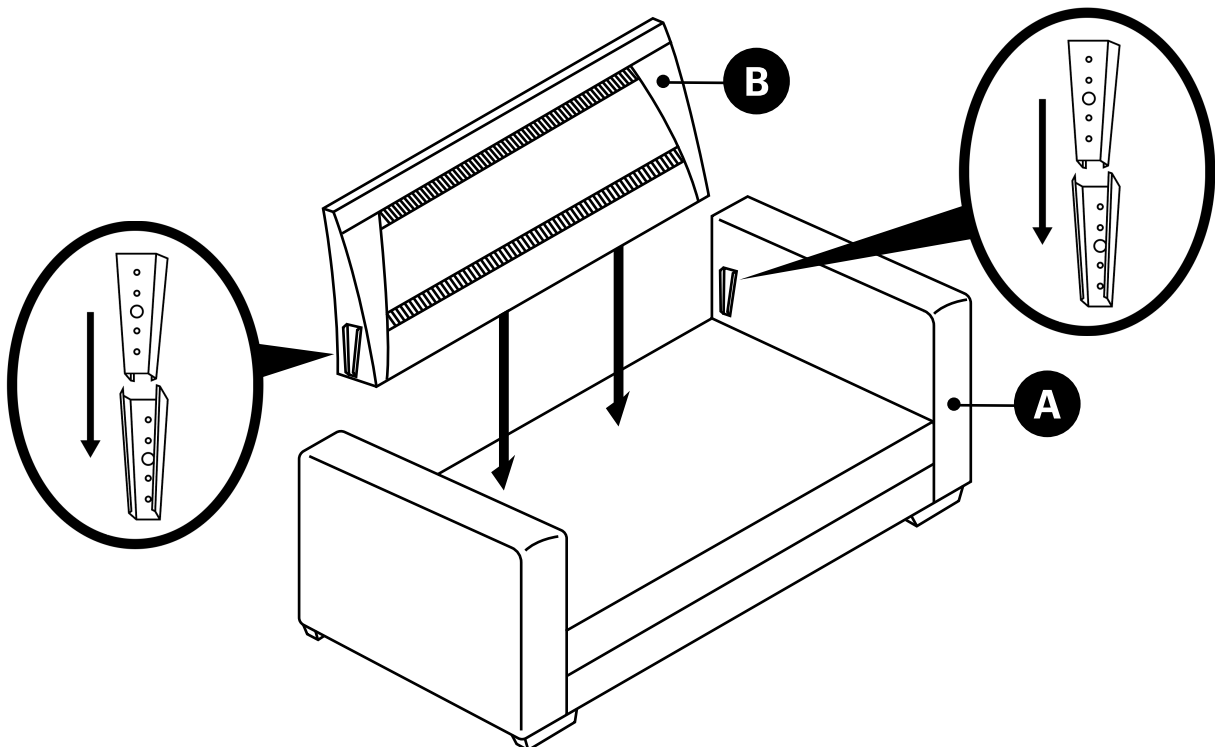



3 Place the seat cushions.

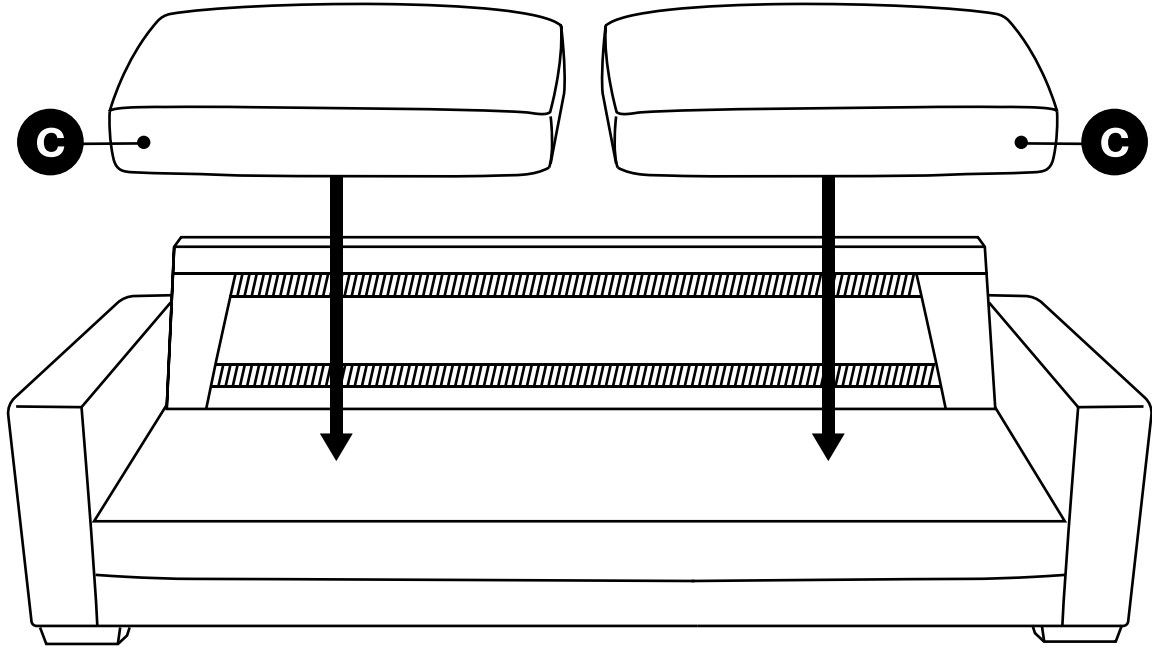

4 Attach the back cushions.
Please align to the velcro on the backrest.

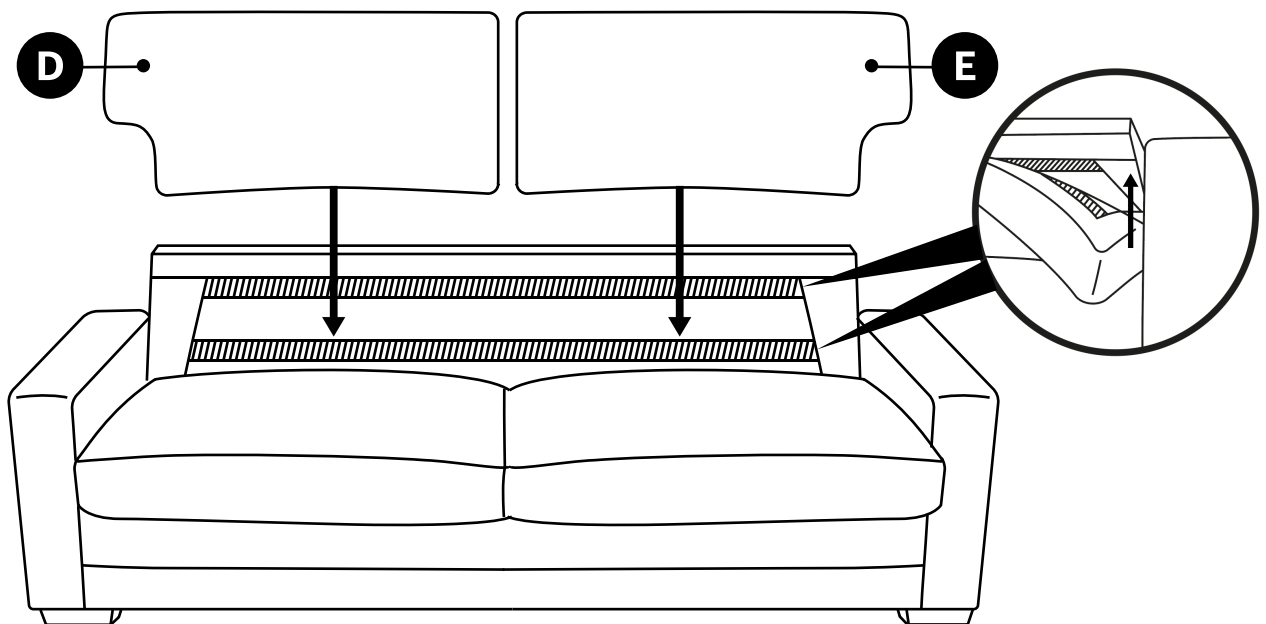



5 Pat and plump the surfaces to reshape and align the cushions as necessary.

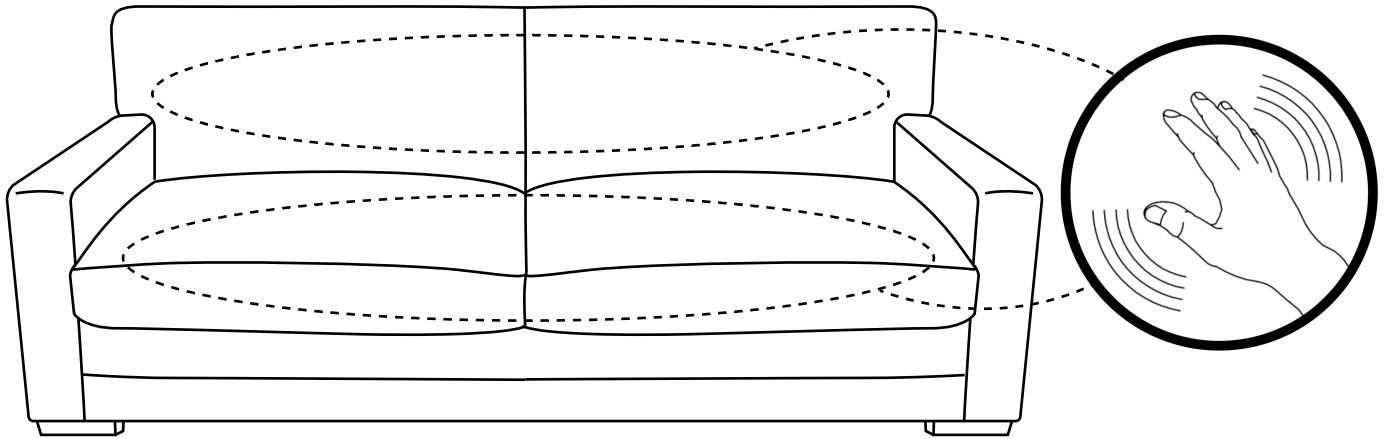

6

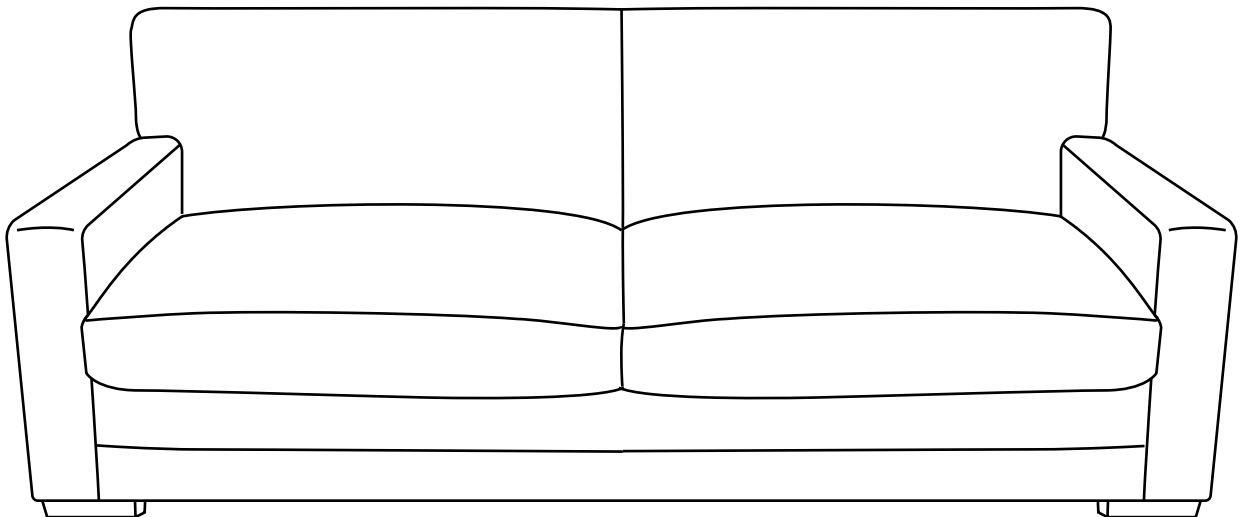



— **Important information - please read before use**



Upholstery and appearance

- Every effort has been made to ensure each piece of furniture matches
- The materials used may have variation in colour and grain – this is a natural characteristic of the material and not a fault
- If the upholstery is creased on delivery, allow it to settle at room temperature
- Creasing in seats and back cushions may appear over time – this is a natural characteristic of the material and not a fault
- Upholstery can have a pile in the weave and look different from various angles and lighting – this is a natural characteristic of the material and not a fault

Cleaning your furniture

- Do not use household cleaning products, bleaches, solvent based cleaners, detergents, corrosives, scourers or abrasives, which can damage surfaces and upholstery
- Dust and vacuum your furniture on a weekly basis with the appropriate upholstery attachment
- Use a clean, soft, lint-free cloth slightly dampened with water to remove dirt or body oils
- For tougher stains, use a soft cloth with a little non-alkaline, non-detergent soap

Caring for your furniture

- Remove spills immediately – do not rub stains and spills, blot them first
- Avoid placing damp clothing, wet towels or printed newspapers directly on the upholstery
- Avoid placing hot cups or plates directly onto the furniture as this can damage the upholstery
- Avoid strong sunlight (such as through patio doors and windows), as this can cause discolouration, fading or surface degradation over time
- Avoid strong sunlight on chrome finishes as this can magnify the heat of the sun
- Avoid sitting on the edge of the cushions as this can cause distortion or permanent wear
- Do not sit on the arms
- Avoid sharp objects such as studs, buckles, jewellery, heels, toys or a pet's claws on the upholstery as this can cause damage
- Greasy and oily hair products can damage upholstery
- Light-coloured upholstery can be at risk of discolouration due to dye transfer from dark or strong-coloured clothing, cushions and throws

Safety notes for recliners

- Ensure the footrest is returned correctly and the mechanism clicks back into place
- Do not put fingers down the side of the mechanism
- Do not sit on the footrest

To avoid structural damage

- Do not stand or jump on the sofa
- Do not sit on the arms
- Do not drag the sofa when moving, instead lift and place carefully

This sofa is for indoor, residential use only.

For more information and support, visit help.furniturechoice.co.uk