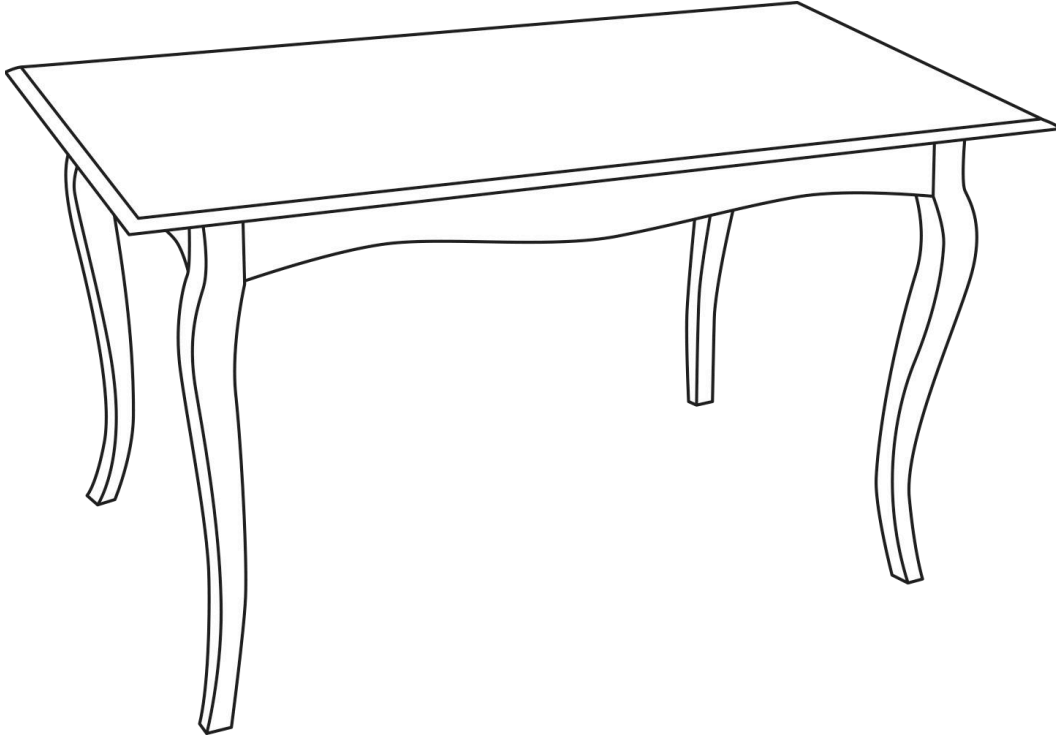

**— Thank you for buying the Clarendon Dining Table****Before you start:****Unpack carefully**

- Take care when unpacking and assembling your table as damaged or scratched items cannot be returned
- Do not use sharp objects
- Be careful not to dispose of the enclosed assembly kit
- Please retain all packaging until you are 100% happy with your table

Before and during assembly

- This table requires 2 people to assemble
- Make sure all items are accounted for and clearly laid out before starting
- Make sure you have enough space to assemble the table safely
- Assemble the table where it will be placed to avoid moving unnecessarily
- Place all parts on a soft and flat surface to avoid damage
- Carefully remove any transit bolts before assembly
- Put all bolts in before fully tightening
- Do not use power tools or overtighten any fittings as this can cause damage

Caution

- Keep small parts, plastic bags and film away from children



— In the box

A x 1

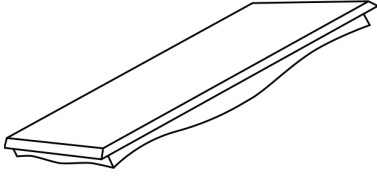

Table Top

B x 4

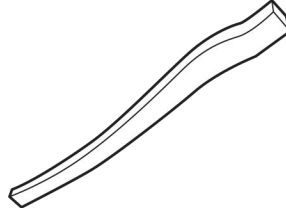

Table Leg

C x 8



Bolt M8x60mm

D x 8

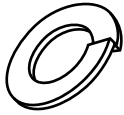

Spring Washer 13mm

E x 8

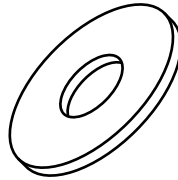

Flat Washer 22mm

F x 1



Allen Key 5mm



- 1** Place the table top on a soft, flat surface. Attach the legs to the table top using the washers and bolts as shown, then tighten with the Allen key.

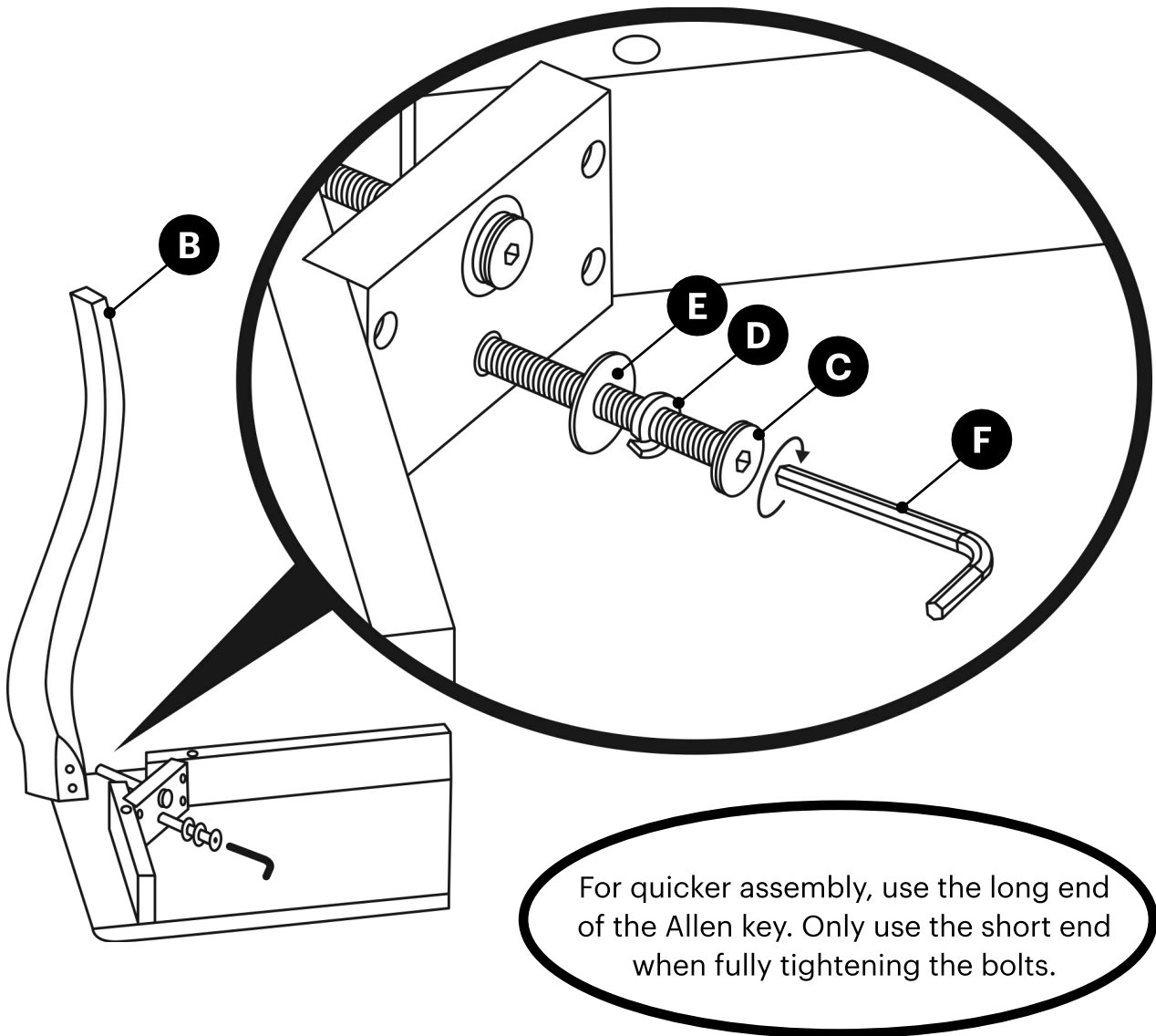



2

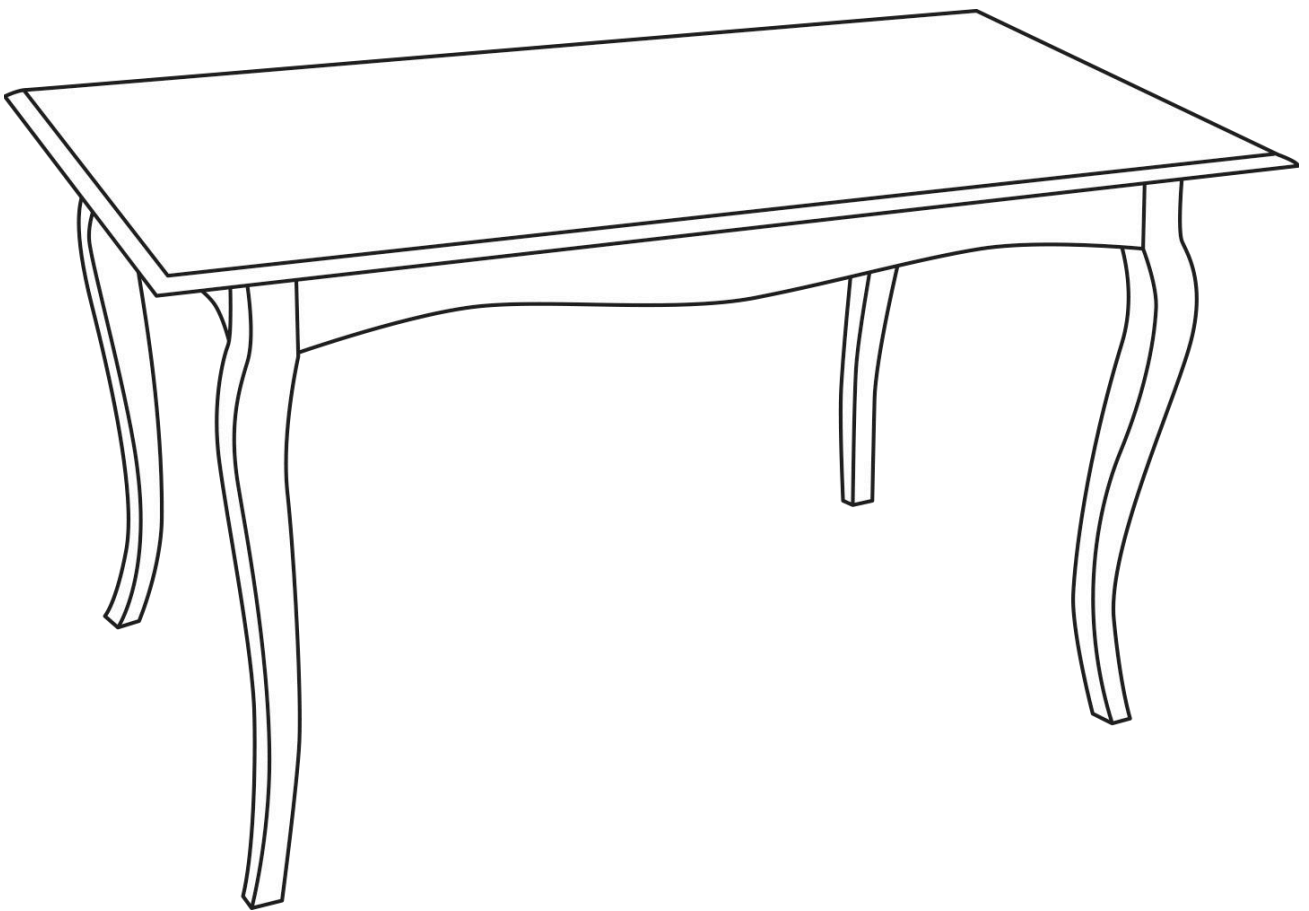



— **Important information - please read before use**



Appearance

- Every effort has been made to ensure each piece of furniture matches
- The materials used may have variation in colour and grain – this is a natural characteristic of the material and not a fault

Cleaning your furniture

- Do not use household cleaning products, bleaches, solvent based cleaners, detergents, corrosives, scourers or abrasives, which can damage surfaces
- Wipe clean with a damp cloth and dry with a soft duster making sure no surfaces are left wet

Caring for your furniture

To avoid deep scratches or surface damage that can impact the integrity, longevity and durability of your table

- Always use place mats or trivets and do not place hot items directly on the table top
- Lift objects off the table instead of dragging them across the surface
- Do not stick adhesive tape on any surfaces
- Remove spills immediately with a damp cloth and dry with a soft duster making sure no surfaces are left wet
- Cleaning and use over time can change the surface colour slightly
- Avoid strong sunlight (such as through patio doors and windows), as this can cause discolouration, fading or surface degradation over time. This can be especially noticeable when compared to areas that are not exposed, such as centre extensions and under table runners
- Avoid strong sunlight on chrome finishes as this can magnify the heat of the sun
- Avoid excessive heat (such as radiators or open fires) as this can cause warping or cracking

To avoid structural damage

- Do not put heavy items on the edge of the table top
- Do not stand or sit on the table
- Do not drag the table when moving, instead lift and place carefully
- Do not use the table unless all the bolts and screws are fully tightened
- Regularly tighten the bolts to avoid damage and maintain stability and strength

This table is for indoor, residential use only.

For more information and support, visit help.furniturechoice.co.uk